

K·JACK®

Free Distribution Newsracks



Wire & Plastic Display Racks



800-775-5225 (Sales & Service)

Visit our website

www.kjack.com , email : kjack@kjack.com

K·JACK®

Free Distribution Newsracks



1

MANY OTHER STYLES AVAILABLE

K·JACK®

Wire Display Racks

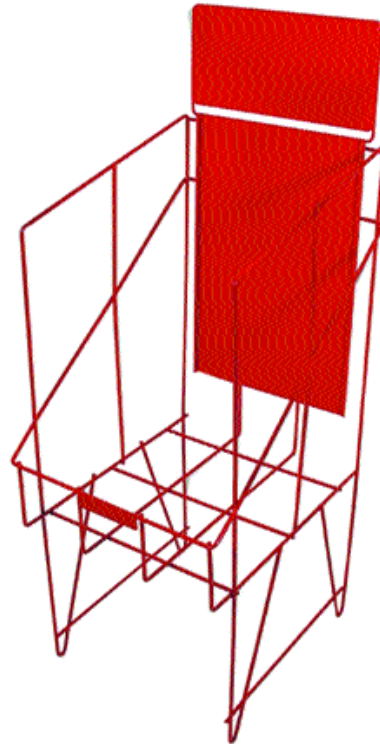

K.Jack quality wire racks allow your newspaper to be sold inside some of the most discreet locations.

Beautifully designed, these practical and unique wire racks fold flat for easy shipping or storage.

Thirty-eight standard paint colors are available for matching a store color or your newspaper colors.

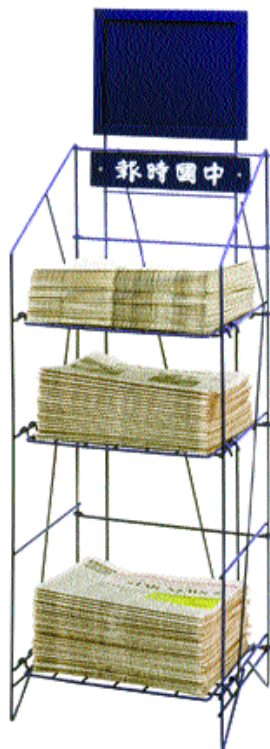

ANY STYLE

CUSTOM WIRE DISPLAY RACKS MADE TO ORDER

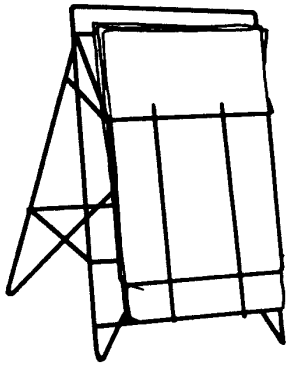

SM - LIT

Literature Rack

This rack is for 8 1/2" x 11" publications.

Size : 9" W x 5 1/2" D
 Base : 9" W x 5 1/2" D
 Basket : 9" W x 3" D

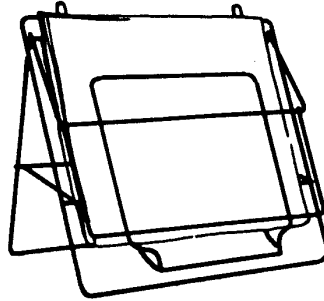

SM - 1C

A collapsible basket and no legs.

For use on counter tops or for hanging from walls.

Size : 16 3/4" H x 19" W
 Base : 19" W x 8 1/4" D
 Basket : 18" W x 6" D

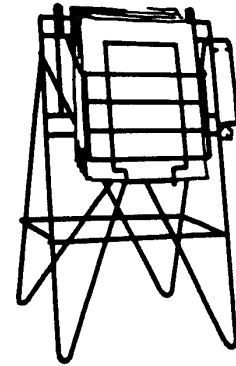

SM - 1T

A collapsible basket specially designed to hold TABLOID newspapers up right

Size : 32 1/4" H x 19" W
 Base : 16 3/4" W x 19" W
 Basket : 13" W x 6" D

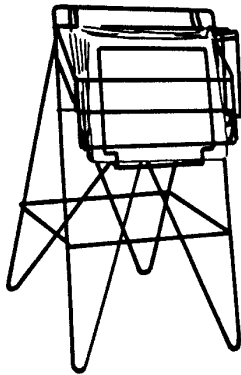

SM - 1

A collapsible basket for standard size newspapers. Has brackets on side for coin tube.

Size : 32 1/4" H x 19" W
 Base : 16 3/4" W x 19" W
 Basket : 18" W x 6" D

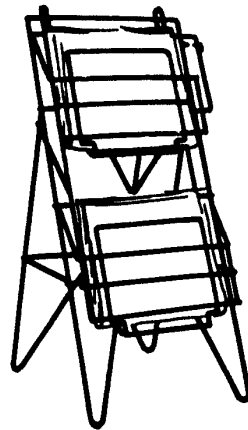

SM - 2

Two collapsible baskets. Ideal for morning and evening editions or for extra capacity.

Size : 32" H x 19" W
 Base : 19" W x 18" D
 Basket : 18" W x 6" D

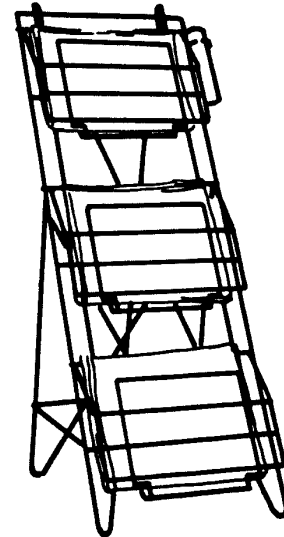

SM - 3

Three collapsible baskets and extra heavy frame to accommodate papers in all the baskets.

Size : 48" H x 19" W
 Base : 19" W x 18" D
 Basket : 18" W x 6" D

WIRE DISPLAY RACKS



SM - 26

Holds a 12" stack of papers.
Also available with a bottom shelf at an extra cost.

Size : 26"H x 16 1/2"W x 17 1/2"D
Base : 16 1/2" W x 17 1/2" D



SM - 26T

Tabloid

Also available with a bottom shelf at an extra cost.

Size : 26"H x 12 1/2"W x 13 1/2"D
Base : 12 1/2"W x 13 1/2"D

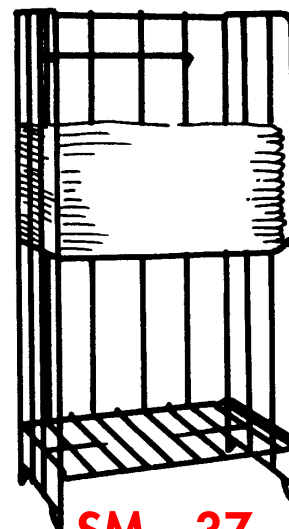

SM - 37

For morning and evening editions or for a large one-paper capacity
Two shelves are standard.

Size : 38"H x 18"W x 12 1/2"D
Base : 18"W x 12 1/2" D

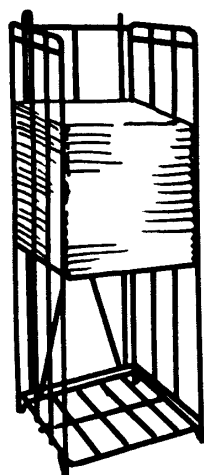

SM - 37T

Tabloid

For tabloid newspapers.
Two flat shelves are standard.

Size : 38" H x 19" W
Base : 19" W x 18" D

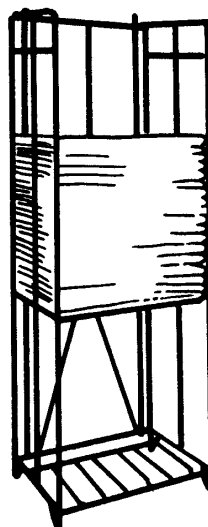

SM - 37Q

Quarterfold

For quarterfold newspapers or 8 1/2" x 11" publications
Two shelves standard.

Size : 32"H x 12 1/2"W x 10 1/4"D
Base : 12 1/2"W x 10 1/4" D

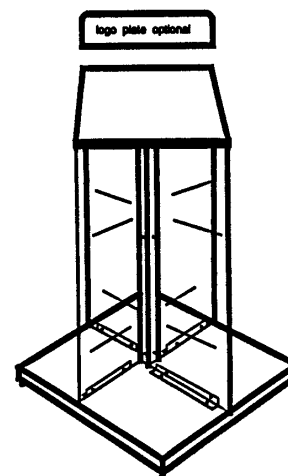

SM - 40

Has four sections 12" x 14" divided by thick plastic. Has 4 swivel caster wheels for easy mobility.

Size : 47"H x 28"W x 28"D
Base : 28"W x 28" D

ANY STYLE
CUSTOM WIRE DISPLAY RACKS MADE TO ORDER



SM - 42

A 42" high newstand for morning & evening editions
Two shelves are standard

Size : 42" H x 8 1/4" W x 11" D
Base : 8 1/4" W x 11" D

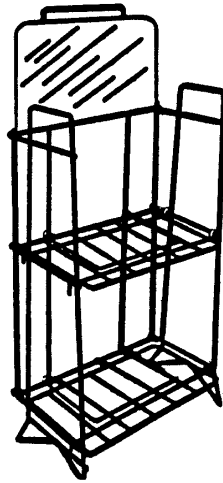

SM - 43 Broadsheet

A 43" high broadsheet newstand for morning & evening editions or for a large one papercapaitites Two shelves are standard

Size : 43" H x 16" W x 13" D
Base : 16" W x 13" D

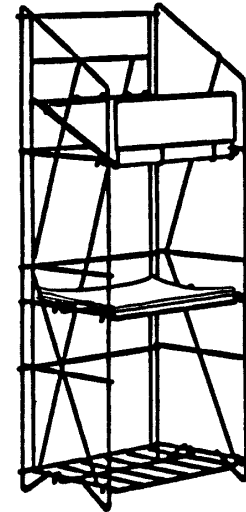

SM - 44

A 44" high newstand that comes with a top shelf that has a 5" capacity and two flat shelves standard in a broadsheet size.

Size : 44" H x 17" W x 12" D
Base : 17" W x 12" D

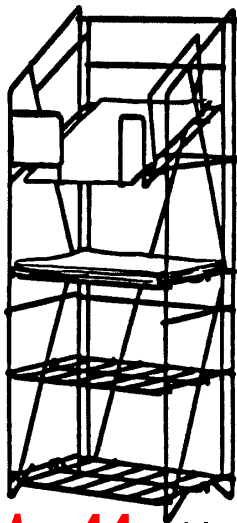

SM - 44 Tabloid

A 44" high tabloid newstand that comes with a top shelf that has a 5" capacity and two flat shelves standard in a tabloid size.

Size : 44" H x 17" W x 12" D
Base : 17" W x 12" D

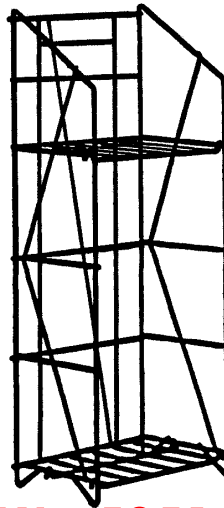

KJ - 5351

A 43" high newstand with bottom shelf optional slanted top or extra flat shelves

Size : 43" H x 17" W x 12" D
Base : 17" W x 12" D



LOW DOUBLE

Has a capacity of 14" stacks on the top shelf and 9" stacks on the bottom shelf. Will accomodate up tp 6 stacks

Size : 30" H x 34" W x 13 1/2" D
Base : 30" W x 11" D

FOUR-BIN

Tubular frame with heavy wire baskets that hold 12" stacks of paper. Legs have non-skid rubber tips to protect floors

Size: 32 1/2" H x 31 1/2"W x 13 1/2"D
Base: 32 1/2"W x 13 1/2" D

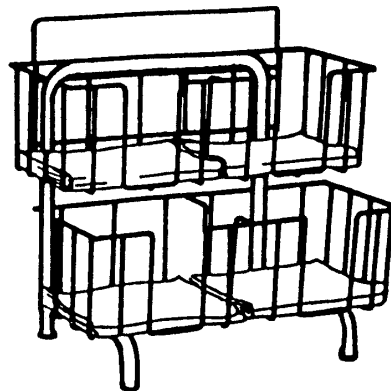

MARKETMATE[®]

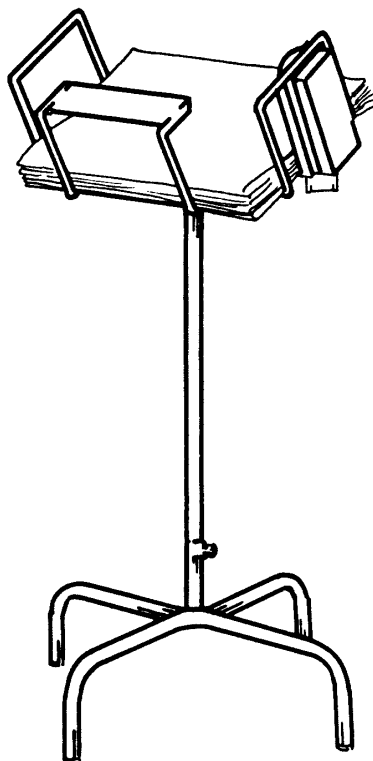

STANDARD FLOOR MODEL

Designed to be counter height which makes it perfect for placement next to checkout counters. This model holds a 4 3/4" stack of papers in a standard or tabloid bin. Coin box is optional.

Size : 36" H
Basket Widths : Standard 16 1/4", Tabloid 13"
Base : 10"W x 20" D

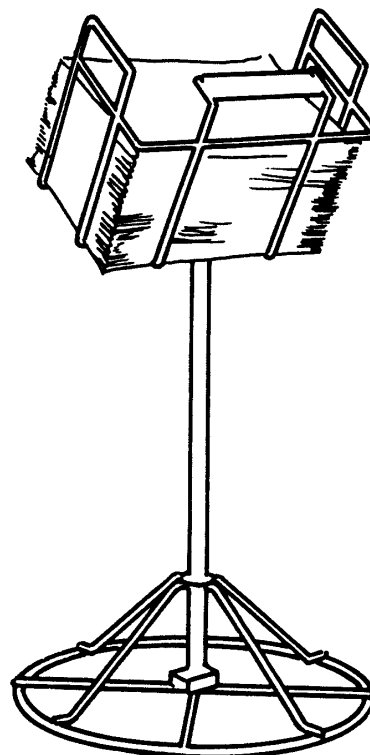

LARGE CAPACITY FLOOR MODEL

This model has a heavier construction than the standard MARKETMATE and has extra capacity to hold 11" stack of papers in a standard or tabloid bin. Coin box is optional.

Size : 42 1/2" H
Basket Widths : Standard 16 1/4", Tabloid 13"
Base : 22"Diameter

**Standard Salesmate[®] Cardholder**

Fits Models : 1, 1-C, 1-T, 2, 3, & 37

Size : 16 3/4" H x 17" W

**SM-8C Cardholder**

Fits Models : 37

Size : 11" H x 17" W (or 18" W)

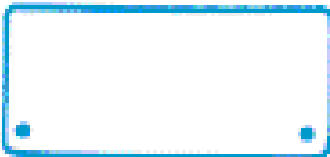
**Sm-3s Logo Plate**

Fits Models : 37T & 37Q

Size: Size : 5 1/2" H x 12" W

**Four-Bin Logo Plate**

Size : 4 1/2" H x 26" W

SM-26 LOGO PLATES

Size : 3" H x 14 7/8" W

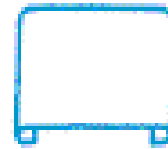

Size : 3" H x 15 5/16" W

SM-44 LOGO PLATES

Small for front top shelf

Size : 4 1/2" H x 5 3/4" W



Large for front top shelf

Size : 4 3/4" H x 14" W



Large for top back

Size : 3 3/4" H x 14 1/2" W



K-JACK® News Stand Display Racks

Sturdy angle iron construction has made K-Jack Display Racks a favorite. Racks that have beautiful appearance, with great display make these units popular with stores and circulators. The legs are easily folded for storage after use.

Solid construction as found in all K-Jack products, make these units last, giving years of durable service. With three different models and twenty-one standard colors to choose from, there is a model for each one of your locations.

With the addition of an optional coin tube, these racks can be converted to Honor Racks.

PART NO.		HEIGHT	SHIPPING WEIGHT
3151	1 place	37-1/2"	15 pounds
3154	4 place	63"	28 pounds
3155	5 place	62"	22 pounds

ANY STYLE
CUSTOM WIRE DISPLAY RACKS MADE TO ORDER

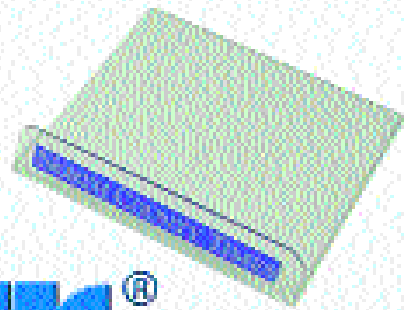

K-JACK[®] Plastic Display Racks

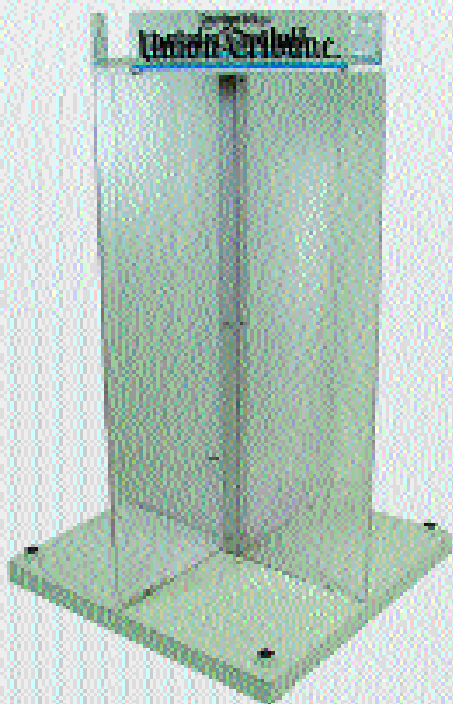

K-Jack's Plastic Display Racks give you the page capacity needed with the stylish look that locations desire.

Graphics are virtually unlimited with the plastic display rack. Let bright vibrant colors help display your paer with a clean look that is pleasing to the eye.

Options available include a Paper Holder Top, Logo Plates, Card Holders and Stenciling.

PART NO.	DESCRIPTION	HEIGHT	SHIPPING WEIGHT	CAPACITY
KJ-534I	Low Plastic	30"	11 lbs.	25"
KJ-533I	Medium Plastic	37"	15 lbs.	32"
KJ-536I	Tall Plastic	45"	19 lbs.	40"

The 30" Plastic Display Rack comes standard with 2 flat shelves. This is the only possible configuration.

The 37" Plastic Display Rack comes standard with 1 slanted shelf and 1 flat shelf. The maximum for this rack is 1 slanted shelf and 3 flat shelves.

The 45" Plastic Display Rack comes standard with 1 slanted shelf and 2 flat shelves. The maximum for this rack is 1 slated shelf and 4 flat shelves. converted to Honor Racks.

PLASTIC COUNTER DISPLAY RACKS

- Promotes impulse buys.
- Durable Lexan® Plastic
- Perfect for supermarkets.
- Round top corners for safety.



K·JACK®

MECHANICAL COIN MECHANISMS

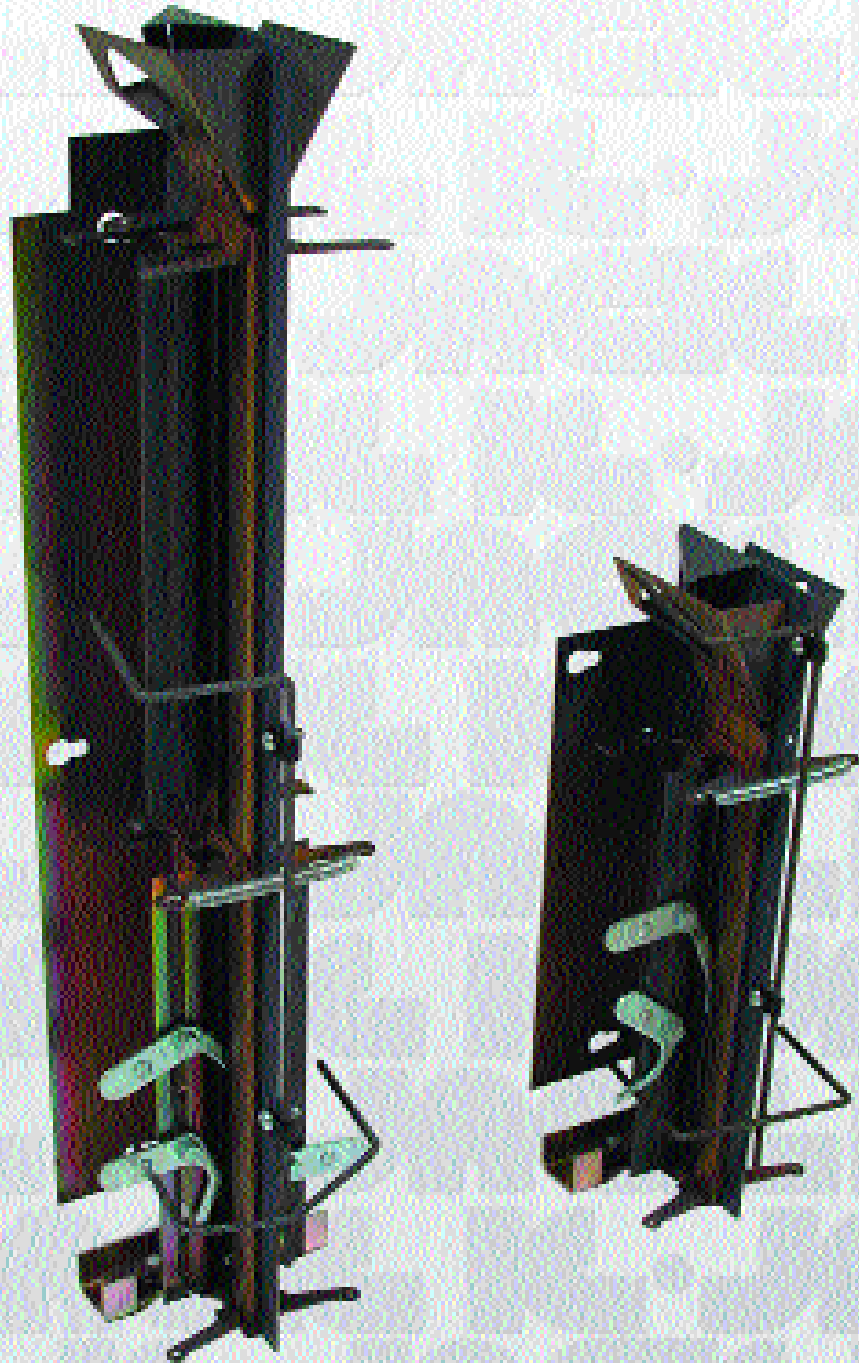



MECHANICAL COIN MECHANISM-ADJUSTING

THE COIN COMBINATION, SHOWN ON THIS PAGE WAS PICKED AS A SAMPLE BECAUSE IT INVOLVES THE USE OF THE THREE BASIC COINS - NICKELS, DIMES & QUARTERS.

THIS MECHANISM HAS BEEN SET FOR A PAPER THAT SELLS FOR 35¢ DAILY AND \$1.25 SUNDAY. AS A CONVENIENCE, IT WILL ACCEPT 2 QUARTERS, NO CHANGE, ON THE DAILY SIDE.

THIS MECHANISM IS SET TO ACCEPT:
PAWL NO. 1 - 1 QUARTER & 1 DIME
PAWL NO. 2 - 2 QUARTERS
PAWL NO. 3 - 1 QUARTER & NICKELS
PAWL NO. 4 - 5 QUARTERS

THE GENERAL INSTRUCTIONS FOR SETTING PAWLS APPLY TO ANY PAWL YOU MAY BE USING.

GENERAL INSTRUCTIONS FOR SETTING PAWLS

- A. WHEN ADJUSTING PAWLS IT SHOULD BE REMEMBERED THAT IN MOST INSTANCES, THE PAWL WILL REST FROM (1/16") TO (1/8") OF AN INCH ABOVE THE UPPERMOST COIN IN THE CHUTE.
- B. IF THE PAWL IS TOO HIGH, THE LATCH WILL NOT BE DEPRESSED FAR ENOUGH TO CLEAR THE MECHANISM LATCH STOP. LOWER PAWL IN INCREMENTS UNTIL THE LATCH WILL CLEANLY CLEAR LATCH STOP AND DOOR OPENS EASILY.

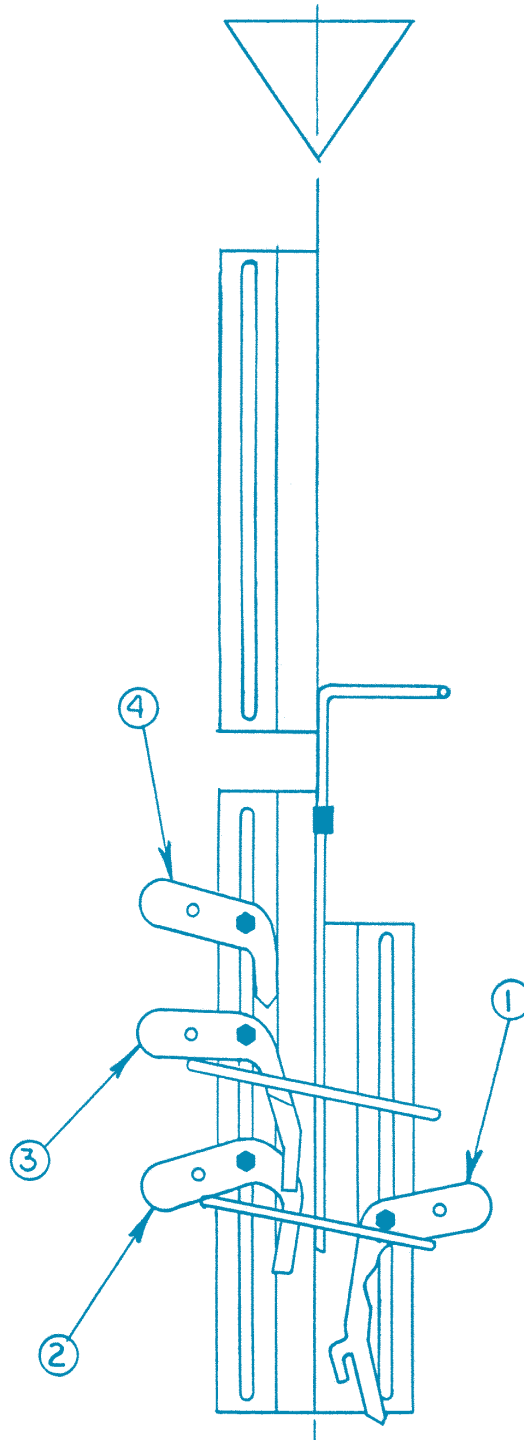

THE INFORMATION CONTAINED IN THIS DOCUMENT IS THE CONFIDENTIAL PROPRIETARY INFORMATION OF K-JACK ENGINEERING COMPANY, INC. AND MAY NOT BE USED IN WHOLE OR IN PART WHATSOEVER CONTRARY TO THE RIGHTS OF THE COMPANY THEREIN. REPRODUCTION DISCLOSURE TO OTHERS IN WHOLE OR IN PART OF ANY PORTION OF THIS DOCUMENT WITHOUT THE COMPANY'S EXPRESS WRITTEN PERMISSION IS FORBIDDEN AND WILL SUBJECT VIOLATORS TO LEGAL ACTION TO ENFORCE THE COMPANY'S RIGHTS.



COIN MECHANISM-LONG

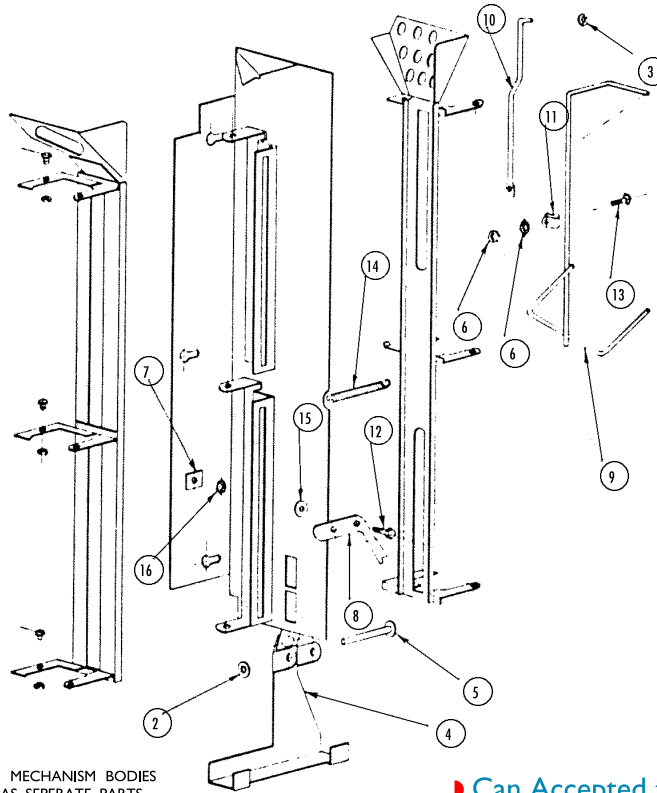

NOTE:
CHUTES & COIN MECHANISM BODIES
ARE NOT SOLD AS SEPERATE PARTS.
BROKEN APART FOR CLARITY.

► Can Accepted the Dollar Coin

C - SPECIFY COLOR		M - SEE PRICE LIST FOR MINIMUM QUANTITIES		D - NOT SHOWN ON DRAWING
REF NO.	CODE	PART NO.	DESCRIPTION	
1	D	KJ-514	COIN MECHANISM - COMPLETE - LONG - DAILY ONLY - (SET FOR YOUR PRICE)	
1	D	KJ-819	COIN MECHANISM - COMPLETE - LONG - DAILY & SUNDAY - (SET FOR YOUR PRICE)	
2	M	KJ-751	FASTENER FOR (3/16") LATCH STOP RIVET PIN	
3	M	KJ-752	FASTENER FOR (1/8") QUICK CHANGE LOCK WIRE	
4		KJ-551	LATCH STOP	
5		KJ-549	LATCH STOP - RIVET PIN	
6	M	KJ-665	NUT - HEX - (6-32)	
7		KJ-577	NUT - PAWL	
8		KJ-573	PAWL	
9		KJ-600	QUICK CHANGE LIFT WIRE - 1 ARM	
9	D	KJ-601	QUICK CHANGE LIFT WIRE - 2 ARM	
10		KJ-594	QUICK CHANGE LOCK WIRE	
11		KJ-674	QUICK CHANGE WIRE CLAMP	
12		KJ-574	SCREW - PAWL	
13	M	KJ-610	SCREW - SLOTTED - (6-32 x 3/8")	
14		KJ-624	SPRING	
15		KJ-575	WASHER - PAWL	
16	M	KJ-576	WASHER - STAR #6	

THE INFORMATION CONTAINED IN THIS DOCUMENT IS THE CONFIDENTIAL PROPRIETARY INFORMATION OF K-JACK ENGINEERING COMPANY, INC. AND MAY NOT BE USED IN WHOLE OR IN PART WHATSOEVER CONTRARY TO THE RIGHTS OF THE COMPANY THEREIN. REPRODUCTION DISCLOSURE TO OTHERS IN WHOLE OR IN PART OF ANY PORTION OF THIS DOCUMENT WITHOUT THE COMPANY'S EXPRESS WRITTEN PERMISSION IS FORBIDDEN AND WILL SUBJECT VIOLATORS TO LEGAL ACTION TO ENFORCE THE COMPANY'S RIGHTS.